

ARTICOLO 1

Mensola pratic

Pratic shelf support

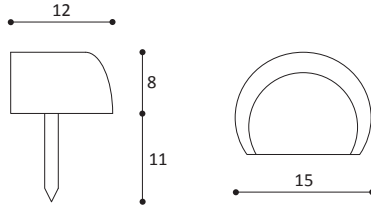

COLORI:
bianco, marrone, nero

 **CONFEZIONE:**
1.000 pezzi

ARTICOLO 94

Mensola con chiodo mobile

Shelf support with removable nail

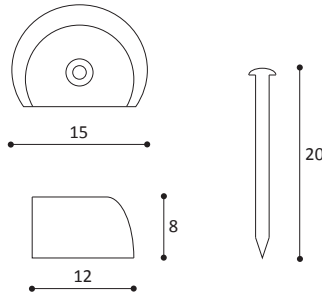

COLORI:
bianco, marrone, nero

 **CONFEZIONE:**
1.000 pezzi

NOTE TECNICHE:
chiodo ottonato

ARTICOLO 94 bis

Mensola con chiodo mobile inserito

Shelf support with pushed removable nail

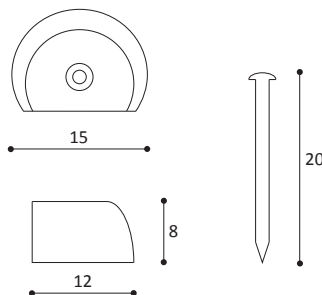

COLORI:
bianco, marrone, nero

 **CONFEZIONE:**
1.000 pezzi

NOTE TECNICHE:
chiodo ottonato

ARTICOLO 27

Mensola a forare

Shelf support "to bore"

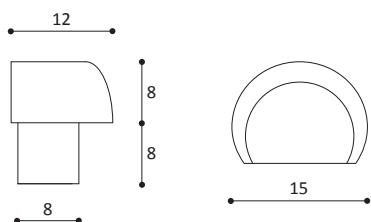

COLORI:
bianco, marrone, nero

 **CONFEZIONE:**
1.000 pezzi

ARTICOLO 30

Mensola cilindrica con chiodo mobile

Cylindrical shelf support with removable nail

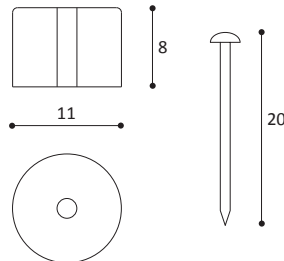

COLORI:
bianco, marrone
nero, grigio



CONFEZIONE:
2.000 pezzi

NOTE TECNICHE:
chiodo ottonato

ARTICOLO 30 bis

Mensola cilindrica con chiodo mobile inserito

Cylindrical shelf support with pushed removable nail

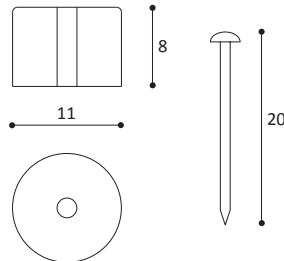

COLORI:
bianco, marrone
nero, grigio



CONFEZIONE:
2.000 pezzi

NOTE TECNICHE:
chiodo ottonato

ARTICOLO 65

Mensola block

Block shelf support

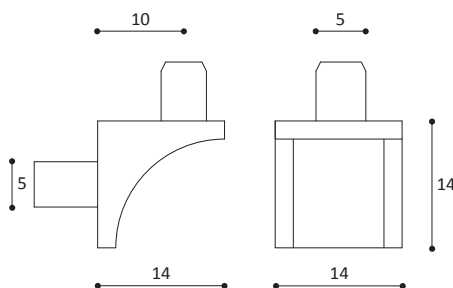

COLORI:
bianco, marrone, nero



CONFEZIONE:
750 pezzi

ARTICOLO 60

Mensola cilindrica

Cylindrical shelf support

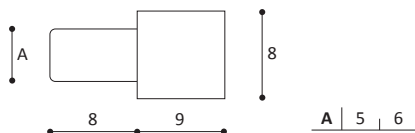

COLORI:
bianco, marrone,
nero, neutro



CONFEZIONE:
2.000 pezzi

ARTICOLO 29

Mensola cilindrica con anello

Cylindrical shelf support with ring

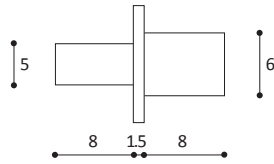

COLORI:
bianco, marrone,
nero, neutro

 **CONFEZIONE:**
2.000 pezzi

ARTICOLO 71*

Perno reggipiano 5x5x16

Pin shelf support 5x5x16

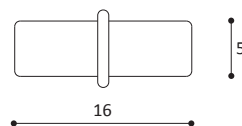

FINITURA:
zincato

 **CONFEZIONE:**
2.000 pezzi

ARTICOLO 190

Reggipiano a click

Click shelf support

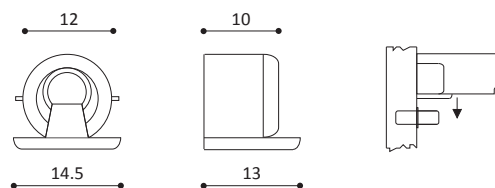

Soddisfa normative UNI-EN 1153 e 1727 relative ai requisiti di sicurezza della struttura dei mobili.



COLORI:
bianco, noce, nero,
grigio alluminio

 **CONFEZIONE:**
2.500 pezzi

ARTICOLO 21

Mensola a poltroncina a scatto

Click stall shelf support

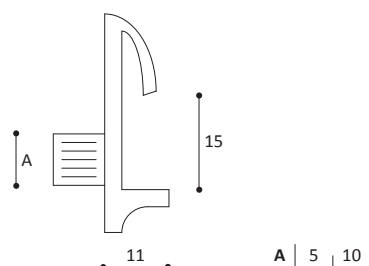

COLORI:
bianco, marrone

 **CONFEZIONE:**
1.250 pezzi

ARTICOLO 63

Mensola pratic a due punti

Pratic shelf support with two nails

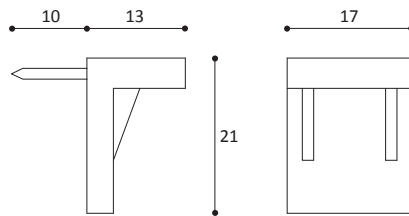

COLORI:
bianco, marrone



CONFEZIONE:
500 pezzi

ARTICOLO 18

Mensola spostabile

Movable shelf support

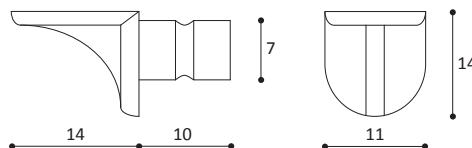

COLORI:
bianco, marrone



CONFEZIONE:
1.000 pezzi

ARTICOLO 19

Bussola per mensola spostabile

Bush for movable shelf support

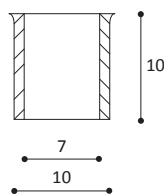

COLORI:
bianco, marrone



CONFEZIONE:
2.000 pezzi

ARTICOLO 28

Mensola con perno metallico

Shelf support with metal pin

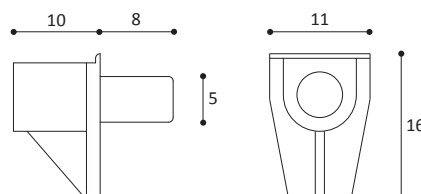

COLORI:
bianco, marrone, nero,
trasparente



CONFEZIONE:
1.000 pezzi

ARTICOLO 64

Mensola a squadra

Square shelf support

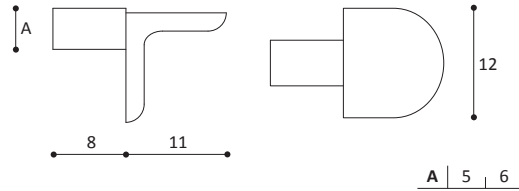

COLORI:
bianco, marrone, nero,
neutro

 **CONFEZIONE:**
1.500 pezzi

ARTICOLO 64 bis

Mensola a squadra zama

Zamak square shelf support

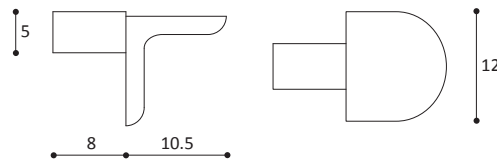

FINITURA:
nichelato

 **CONFEZIONE:**
1.000 pezzi

ARTICOLO 295

(MAGIC) Supporto nylon

Nylon support

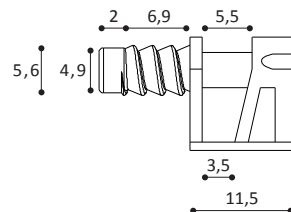

COLORI:
bianco, grigio alluminio

 **CONFEZIONE:**
1.000 pezzi

ARTICOLO 294

(MAGIC) Basetta da incasso

Connector press-fit

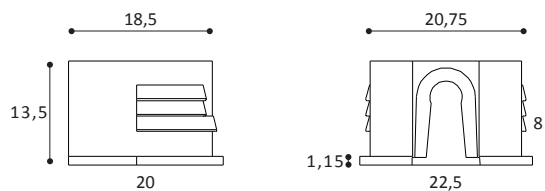

COLORI:
bianco, grigio alluminio

 **CONFEZIONE:**
1.000 pezzi

ARTICOLO 204

Reggipiano in lega di nylon a 2 spine

Alloy nylon shelf support with two pins

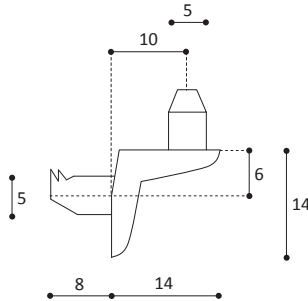

COLORI:
grigio alluminio



CONFEZIONE:
2.000 pezzi

ARTICOLO 204 bis

Reggipiano a 2 spine zama

Zamak shelf support with two pins

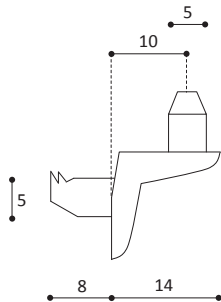

FINITURA:
nichelato



CONFEZIONE:
2.500 pezzi

ARTICOLO 201

Reggipiano in lega di nylon a una spina

Alloy nylon shelf support with one pin

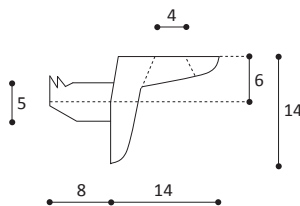
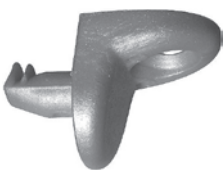

COLORI:
grigio alluminio



CONFEZIONE:
2.000 pezzi

ARTICOLO 205

Reggipiano in lega di nylon per eurovitee

Alloy nylon shelf support for euroscrew

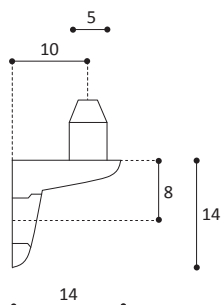

COLORI:
grigio alluminio



CONFEZIONE:
2.000 pezzi