

ARTICOLO 1

**Mensola pratic**

Pratic shelf support

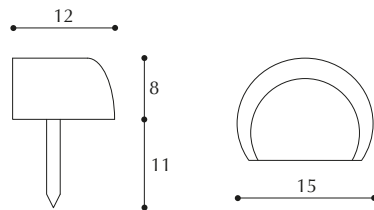

**COLORI:**  
bianco, marrone, nero



**CONFEZIONE:**  
1.000 pezzi

ARTICOLO 94

**Mensola con chiodo mobile**

Shelf support with removable nail

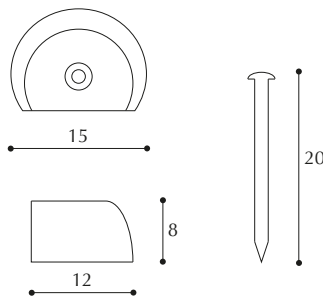

**COLORI:**  
bianco, marrone, nero



**CONFEZIONE:**  
1.000 pezzi

**NOTE TECNICHE:**  
chiodo ottonato

ARTICOLO 94 bis

**Mensola con chiodo mobile inserito**

Shelf support with pushed removable nail

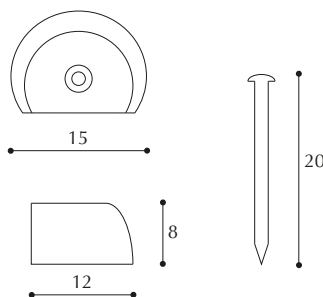

**COLORI:**  
bianco, marrone, nero



**CONFEZIONE:**  
1.000 pezzi

**NOTE TECNICHE:**  
chiodo ottonato

ARTICOLO 27

**Mensola a forare**

Shelf support "to bore"

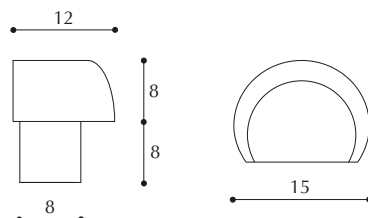

**COLORI:**  
bianco, marrone, nero



**CONFEZIONE:**  
1.000 pezzi

ARTICOLO 1 bis

**Mensola cilindrica pratic**

Pratic cylindrical shelf support

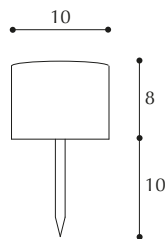

**COLORI:**  
marrone, bianco

**CONFEZIONE:**  
2.000 pezzi

ARTICOLO 30

**Mensola cilindrica con chiodo mobile**

Cylindrical shelf support with removable nail

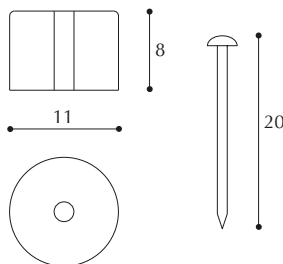

**COLORI:**  
bianco, marrone  
nero, grigio

**CONFEZIONE:**  
2.000 pezzi

**NOTE TECNICHE:**  
chiodo ottonato

ARTICOLO 30 bis

**Mensola cilindrica con chiodo mobile inserito**

Cylindrical shelf support with pushed removable nail

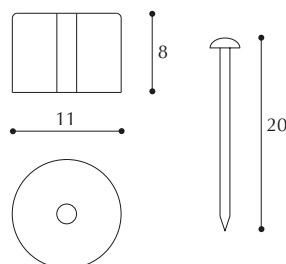

**COLORI:**  
bianco, marrone  
nero, grigio

**CONFEZIONE:**  
2.000 pezzi

**NOTE TECNICHE:**  
chiodo ottonato

ARTICOLO 65

**Mensola block**

Block shelf support

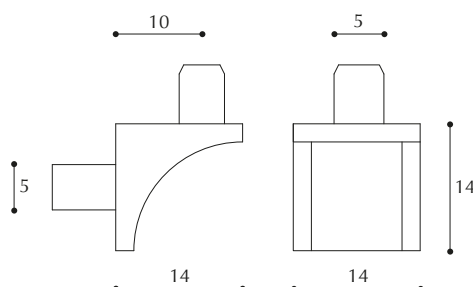

**COLORI:**  
bianco, marrone, nero

**CONFEZIONE:**  
750 pezzi

ARTICOLO 60

**Mensola cilindrica**

Cylindrical shelf support

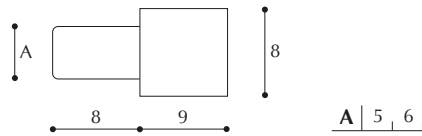

**COLORI:**  
bianco, marrone,  
nero, neutro



**CONFEZIONE:**  
2.000 pezzi

ARTICOLO 29

**Mensola cilindrica con anello**

Cylindrical shelf support with ring

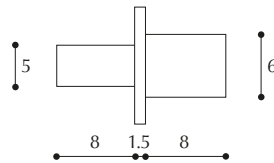

**COLORI:**  
bianco, marrone,  
nero, neutro



**CONFEZIONE:**  
2.000 pezzi

ARTICOLO 71\*

**Perno reggipiano 5x5x16**

Pin shelf support 5x5x16

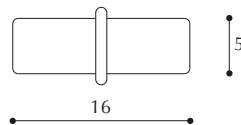

**FINITURA:**  
zincato



**CONFEZIONE:**  
2.000 pezzi

ARTICOLO 21

**Mensola a poltroncina a scatto**

Click stall shelf support

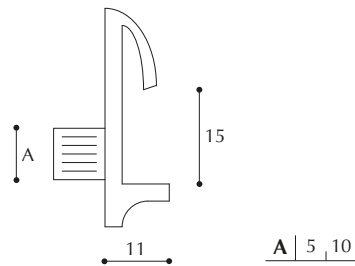

**COLORI:**  
bianco, marrone

**CONFEZIONE:**  
1.250 pezzi

ARTICOLO 63

**Mensola pratic a due punti**

Pratic shelf support with two nails

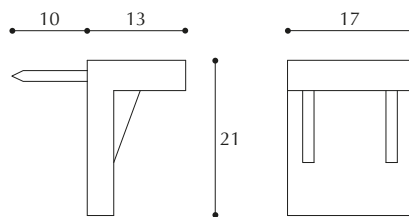

**COLORI:**  
bianco, marrone

**CONFEZIONE:**  
500 pezzi

ARTICOLO 18

**Mensola spostabile**

Movable shelf support

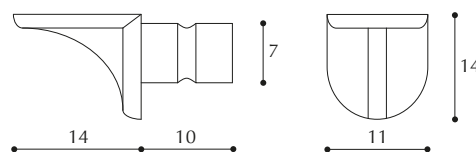

**COLORI:**  
bianco, marrone

**CONFEZIONE:**  
1.000 pezzi

ARTICOLO 19

**Bussola per mensola spostabile**

Bush for movable shelf support

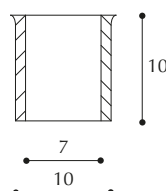

**COLORI:**  
bianco, marrone

**CONFEZIONE:**  
2.000 pezzi

ARTICOLO 28

**Mensola con perno metallico**

Shelf support with metal pin

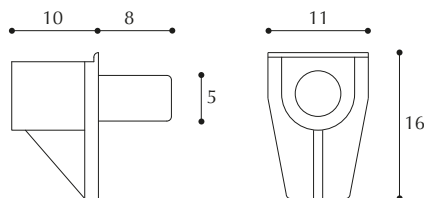

**COLORI:**  
bianco, marrone, nero,  
trasparente

**CONFEZIONE:**  
1.000 pezzi

ARTICOLO 64

**Mensola a squadra**

Square shelf support

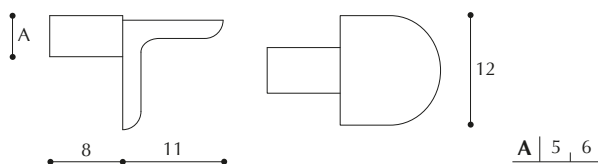

**COLORI:**  
bianco, marrone,  
nero, neutro

**CONFEZIONE:**  
1.500 pezzi

ARTICOLO 64 bis

**Mensola a squadra zama**

Zamak square shelf support

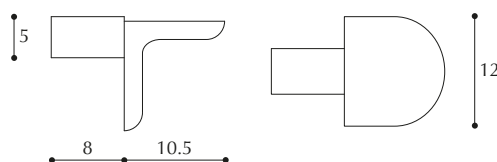

**FINITURA:**  
nichelato

**CONFEZIONE:**  
1.000 pezzi

ARTICOLO 190

**Reggipiano a click**

Click shelf support

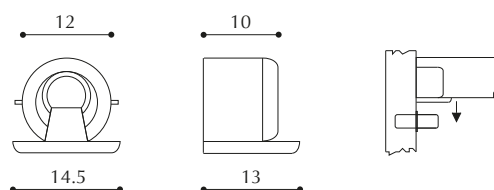

**COLORI:**  
bianco, noce, nero  
grigio alluminio

**CONFEZIONE:**  
2.500 pezzi

*Soddisfa normative UNI-EN 1153 e 1727 relative ai requisiti di sicurezza della struttura dei mobili.*

ARTICOLO 204

## Reggipiano in lega di nylon a 2 spine

Alloy nylon shelf support with two pins

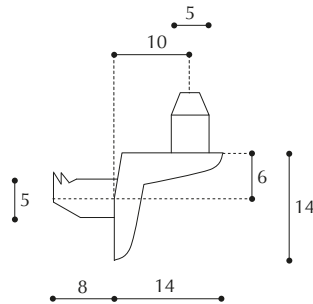

**COLORI:**  
grigio alluminio



**CONFEZIONE:**  
2.000 pezzi

ARTICOLO 204 bis

## Reggipiano a 2 spine zama

Zamak shelf support with two pins

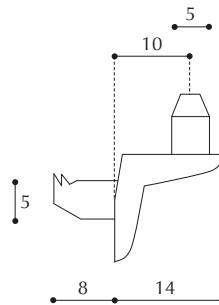

**FINITURA:**  
nichelato



**CONFEZIONE:**  
2.500 pezzi

ARTICOLO 201

## Reggipiano in lega di nylon a una spina

Alloy nylon shelf support with one pin

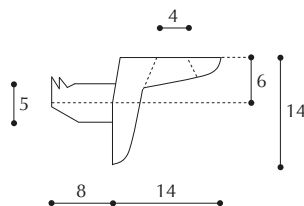

**COLORI:**  
grigio alluminio



**CONFEZIONE:**  
2.000 pezzi

ARTICOLO 205

## Reggipiano in lega di nylon per eurovite

Alloy nylon shelf support for euroscrew

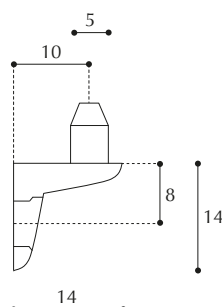

**COLORI:**  
grigio alluminio



**CONFEZIONE:**  
2.000 pezzi